

FURUNO

CHART RADAR



Models:
FAR-3000 series

FURUNO FAR-3000 Chart Radar offers the r and navigation safety by greatly enhanced t

Newly developed antennas with enhanced high durability and reliability



- ▶ **Newly designed antenna scanners to suppress the aerodynamic drag and prevent a spike in temperature**
- ▶ **Less maintenance required through use of the DC brushless motor**
- ▶ **Ethernet network link between antenna unit and below deck processor unit**
The analog signals are converted into the digital signals within the antenna unit and sent to the below deck processor unit via Ethernet network. This network technology eliminates loss of signal gain between antenna unit and processor unit that may be seen in conventional Radar system.
- ▶ **Optional LAN Signal Converter enables users to extend the cable between antenna unit and processor unit or to utilize the existing cables when retrofitting**

Solid State Radar model - NXT - specializes in target detection and maintainability

Compared to the traditional Magnetron Radar, the Solid State Radar NXT Series provide highly reliable target detection while requiring low power.

▶ **Clear images**

Furuno Solid State Radar technology generates clear echo images, which allows users to obtain a clear picture of the area around their vessel, including weaker echoes from small crafts.

▶ **Reducing the time and cost for maintenance**

- No need to replace the magnetron
- Removal of the consumable parts thanks to a fan-less antenna (S-band only)

Power Amplifier Module of the Solid State transceiver

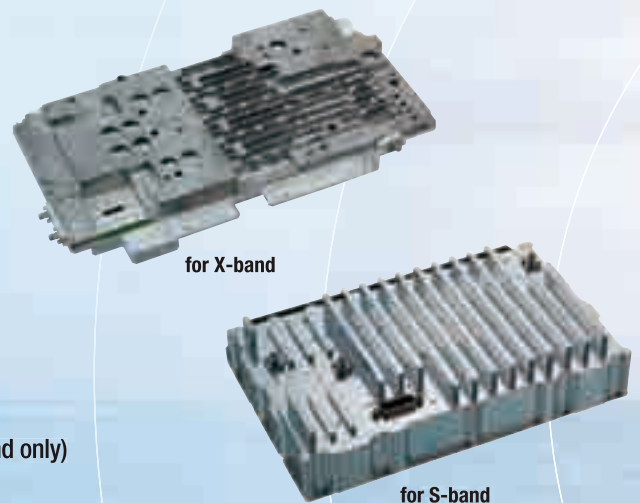

Reliable situation awareness target detection

▶ Automatic Clutter Elimination (ACE) function provides clear echoes

Users can quickly adjust the radar image with a single action. When Automatic Clutter Elimination (ACE) function is activated, the system automatically adjusts the clutter reduction filter and gain control according to the sea and weather conditions selected (Calm/Rough Sea/Hard Rain).

Our advanced echo averaging architecture is also incorporated into Automatic Clutter Elimination (ACE) function. Users can avoid complicated adjustment processes, resulting in clear echo images.

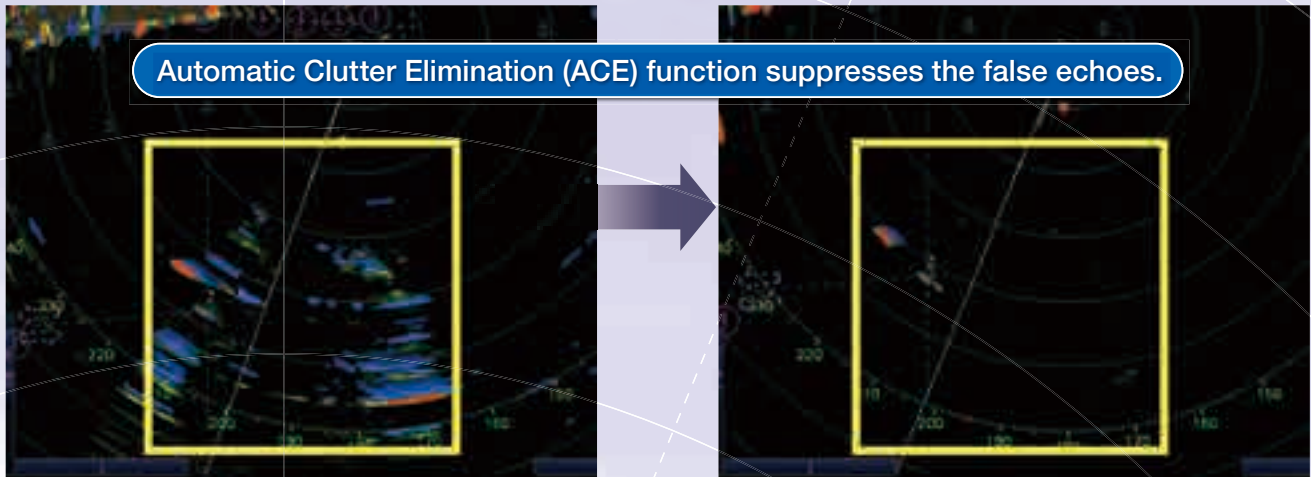

Automatic Clutter Elimination (ACE)
OFF

Automatic Clutter Elimination (ACE)
ON

▶ Improved Target Tracking (TT) function

- Target acquisition takes only a few seconds



- Acquired target does not jump to adjacent target
- Reliable and stable tracking of high-speed and rapidly maneuvering vessels

▶ High performance Radar with Cat.1 and Cat.2 support

▶ Complies with the following regulations:

- IEC 60945 Ed. 4.0
- IEC 61162-1 Ed. 5.0
- IEC 61162-2 Ed. 1.0
- IEC 61162-450 Ed. 1.0
- IEC 61174 Ed. 4.0
- IEC 62288 Ed. 2.0
- IEC 62388 Ed. 2.0

Advanced technologies for safer and optimal navigation in all kinds of situations (option)

Wave Analyzer Software *

- Allows real-time monitoring and analysis of wave echoes
- Ensures safety at sea even at night

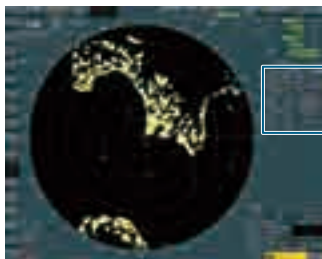

*More details on the Wave Analyzer brochure

Ice Mode ** (X-band magnetron only)

- Find the best route through ice
- Observe ice conditions by Radar

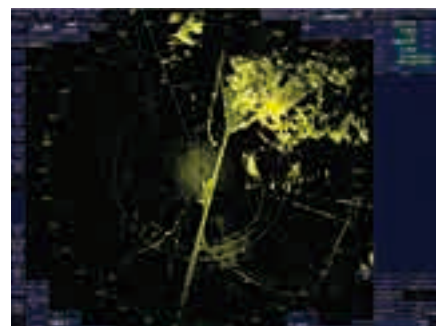

**Please contact your local distributor for more details

Multi Function Display (MFD) capability*

Furuno proposes workstations that combine flexibility and redundancy. Users may easily select ECDIS, Chart Radar, Conning display or Alert Management System at any multi-function display. Navigators will enjoy reduced workload and significant freedom to move about the bridge. All necessary information is available on a variety of displays and at locations that may be altered as required.

*MFD capability is to be implemented as software upgrade

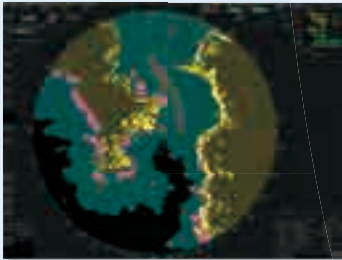

Radar (Chart ON)



Radar (Chart OFF)



ECDIS



Conning Information Display

Sensor Adapter

► Common sensor adaptor makes installation and maintenance easy

The Sensor Adapter acts as a central medium to gather all of the sensor data and collectively feed it to all FAR-3000 Chart Radar and FMD-3200/3300 ECDIS in the network. Since the sensor adapter can be extended to interface with all the sensors within the network, individual cable connections in the sensor-to-Chart Radar/ECDIS interface can be greatly reduced.



Navigation sensors can be directly interfaced with the processor's 8 serial I/O ports. Sensor adapters are required under the following conditions:

- The sensor data is to be shared amongst multiple networked Chart Radar and ECDIS systems,
- The number of sensors interfaced is more than the number of the ports the processor has (8 serial I/O ports, 1 digital IN and 6 digital OUT), and/or
- The networked sensors include analog sensors.

In order to integrate onboard sensors into the navigation network, the sensor adapter may be interfaced with the switching hub HUB-100 from which distribution of the sensor data throughout the network is possible. Alternatively, multiple sensor adapters may be interfaced via Ethernet to integrate onboard sensors for use in the shipboard network.

System diagram for the new Chart Radar

Model: FAR-3000

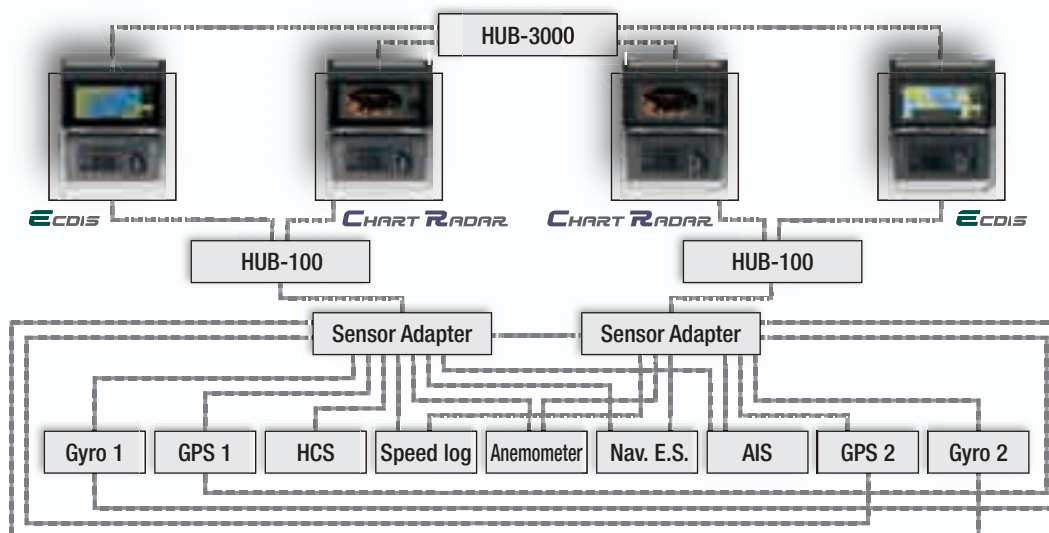

FURUNO's new user interface delivers straightforward operation

Unique & smart operation tool – “Status bar” and “InstantAccess bar™”

The user interface of the Radar utilizes carefully organized operational tools: the Status bar and the InstantAccess bar™. These operational tools deliver straightforward, task-based operation by which the operator can quickly perform tasks without having to navigate an intricate menu tree.

Status bar

Status bar contains information about the operating status, i.e., MFD operating mode, main tasks assigned to each MFD operating mode.

InstantAccess bar™

InstantAccess bar™ contains all the tasks (functions or actions) corresponding to the operation mode currently selected so that quick access to necessary functions/actions can be made.



Stress-free operation with the well-designed control unit



Intuitive operation

All operations can be controlled with the trackball.

Contextual menu

The context menu contains all the available actions related to the selected icon or area, it provides quick access to tasks.



SPECIFICATIONS

PRODUCT NAME

MARINE RADAR

GENERAL

Range Scales and Ring Intervals

Range (NM)	0.125	0.25	0.5	0.75	1.5	3	6	12	24	48	96
RI (NM)	0.025	0.05	0.1	0.25	0.25	0.5	1	2	4	8	16
Number of rings	5	5	5	3	6	6	6	6	6	6	6

ANTENNA UNIT

Radiator Type Slotted waveguide array

Beamwidth and Sidelobe

Radiator Type	XN12CF	XN20CF	XN24CF	SN36CF
Length	4 ft	6.5 ft	8 ft	12 ft
Frequency	X band: 9410±30 MHz			S band: 3050±30 MHz
Beamwidth (H) (-3 dB)	1.9°	1.23°	0.95°	1.8°
Beamwidth (H) (-20 dB)	4.5°	2.9°	2.4°	4.5°
Beamwidth (V)	20°	20°	20°	25°
Sidelobe (within ±10°)	-24 dB	-28 dB	-28 dB	-24 dB
Sidelobe (outside ±10°)	-30 dB	-32 dB	-32 dB	-30 dB

TRANSCEIVER UNIT

Transceiver Unit	Magnetron				
Frequency	RTR-105	RTR-106	RTR-108	RTR-107	RTR-109
	X band: 9410±30 MHz			S band: 3050±30 MHz	
Output Power	12 kW	25 kW		30 kW	
Transceiver Unit	Solid State				
Frequency	RTR-123 (X band)			RTR-111 (S band)	
	①PON: 9403.75 MHz/QON: 9423.75 ±5MHz ②PON: 9413.75 MHz/QON: 9433.75 ±5MHz			①PON: 3043.75 MHz/QON: 3063.75±5 MHz ②PON: 3053.75 MHz/QON: 3073.75±5 MHz	
Output Power	600 W			250 W	

Range scale, Pulse Repetition Rate and Pulselength

Magnetron radar: FAR-3210/3310/3220/3320/3320W

FAR-3230S/3330S/3330SW

PRR (Hz approx.)	Range scale (NM)										
	0.125	0.25	0.5	0.75	1.5	3	6	12	24	48	96
3000	S1										
3000	S2										
1500	M1										
1200	M2										
1000	M3										
600*	L										

*: 500 Hz on 96 NM range.

Solid state radar: FAR-3220-NXT/3230-NXT

PRR (Hz approx.)	Range scale (NM)										
	0.125	0.25	0.5	0.75	1.5	3	6	12	24	48	96
1500	S1										
1500	S2										
1200	M1										
1000	M2										
1000	M3										
600	L										

Solid state radar: FAR-3230S-SSD/3330S-SSD

PRR (Hz approx.)	Range scale (NM)										
	0.125	0.25	0.5	0.75	1.5	3	6	12	24	48	96
2400	S1										
2000	S2										
1500	M1										
1060	M2										
1000	M3										
600	L										

PROCESSOR UNIT

Chart Materials IMO/IHO S57 edition-3 ENC vectorized material (IHO S-63 ENC data protection scheme), C-MAP and CM-93/3 vectorized materials

Data Presentation

Own Ship Own ship's mark and numeral position in lat/lon, speed and course
Target Data(TT: ARPA, AIS) Range, bearing, speed, course, CPA/TCPA, BCR/BCT Target information from AIS (waypoint, ship's hull and status)

Position Calculation

Navigation by result from external position sensor
Dead reckoning with gyro and log data from gyro, log, and position sensors to be fed to mathematical filter to generate highly accurate position and speed

Navigation Planning

Route Monitoring Off-track display, waypoint arrival alarm, shallow depth alarm
User Chart User chart creation and display
Notes Data Create and display notes data
MOB (Man Overboard) Position, and other data at time of man overboard are recorded MOB mark is displayed on the screen

DISPLAY UNIT

Display Unit	MU-190	MU-231	MU-270W
Display Type	19" color LCD	23.1" color LCD	27" color wide LCD
Resolution	SXGA(1280x1024 pixels)	UXGA(1600x1200 pixels)	WUXGA(1920x1200 pixels)

INTERFACE

Processor Unit

DVI 2 ports, DVI-D (Video signal from DVI-1 and DVI-2 is identical)
1 port, DVI-I Ver. 1.1 (RGB for VDR)
LAN 2 ports, Ethernet 1000 Base-T (for Interswitch and Sensor Adapter)
1 port, 100 Base-TX (for Radar sensor)
USB 4 ports, USB 2.0 type-A
COM 2 ports, RS232C/RS-485 (for brilliance control)
Serial I/O 8 ports
IEC61162-1/2 (2 ports), IEC61162-1 (6 ports)

Sentences

Input ABK, ACK, ACM, ALR, CUR, DBT, DPT, DTM, GGA, GLL, GNS, HBT, HDT, MTW, MWV, RMC, THS, VBW, VDM, VDO, VDR, VHW, VTG, ZDA
Output ABM, ACK, ALC, ALF, ALR, ARC, BBM, EVE, HBT, OSD, RSD, TLB, TTD, TTM, VSD
Digital Input 1 port (for ACK signal input)
Contact Closure 6 ports
1 port for system fail, 1 port for power fail, 2 ports for normal close, and 2 ports for normal open

Sensor Adapter

Control and Serial Input

LAN 1 port, Ethernet 100 Base-TX
Serial 8 ports
IEC 61162-1/2 (4 ports), IEC 61162-1 (4 ports)
Analog Input 3 ports/per unit, -10 to +10 V/0 to 10 V, 4 to 20 mA selectable
Digital Input 8 ports/per unit, normal close or open, selectable
Digital Output 8 ports/per unit, normal close or open, selectable

POWER SUPPLY

Monitor unit

MU-270W 100-230 VAC; 0.7-0.4 A, 1 phase, 50/60Hz
MU-231 100-230 VAC; 1.0-0.6 A, 1 phase, 50/60Hz
MU-190 100-230 VAC; 0.7-0.4 A, 1 phase, 50/60Hz

Processor unit 100/230 VAC, 1 phase, 50/60 Hz

Power Supply Unit

FAR-3210/3310 100-230 VAC; 1.8-0.9 (2.5-1.2) A, 1Φ, 50/60 Hz
FAR-3220/3320/3320W 100-230 VAC; 2.0-1.0 (2.8-1.3) A, 1Φ, 50/60 Hz
FAR-3220-NXT/3320-NXT 100-230 VAC; 1.8-0.9 (2.5-1.2) A, 1Φ, 50/60 Hz
FAR-3230S/3330S/3330SW 100-230 VAC; 2.8-1.3 (5.1-2.3) A, 1Φ, 50/60 Hz
FAR-3230S-SSD/3330S-SSD 100-230 VAC; 2.3-1.1 (4.7-2.1) A, 1Φ, 50/60 Hz
() : 42 rpm

ENVIRONMENTAL CONDITIONS

Unit	Ambient Temperature	Relative Humidity	Degree of protection	Vibration
Antenna Unit	-25°C to +55°C (storage +70°C)	95% or more at 40°C	IP56	IEC 60945 Ed. 4
Power Supply Unit			IP20	
Processor Unit	IP20			
Control Unit	IP22			
Sensor Adapter	IP22			
Monitor Unit	IP22			

EQUIPMENT LIST

Standard

Display Unit MU-190/231/270W 1 unit
Processor Unit EC-3000 1 unit
Control Unit 1 unit
Radar Control Unit RCU-025 1 unit (specify when ordering)
Trackball Control Unit RCU-026
Antenna Radiator XN12CF/XN20CF/XN24CF/ SN36CF 1 unit
Transceiver RTR-105/106/107/108/109/111/123 1 unit
Gear Box RSB-128/129/130/131/133 1 unit
Performance Monitor PM-32A/32B/52A/52B 1 unit
Power Supply Unit PSU-014/015/016/018 1 unit
Cable between Power Supply Unit and Antenna Unit 1 pc
LAN Cable between Processor Unit and Power Supply Unit 1 pc
Standard Spare Parts and Installation Materials 1 set

Option

Sensor Adapter MC-3000S/3010A/ 3020D/3030D
Sub Display Radar Cable RW-00136
Deicer OP03-226/227/231/232
Junction Box (for foremast mounting) RJB-001
Composite Cable between Junction Box and Antenna/ Power Supply Unit (for foremast mounting) RW-9600
LAN Signal Converter (for foremast mounting) OP03-223
Switching Hub for sensor network HUB-100
Intelligent Hub for interswitch network HUB-3000
Wave Analyzer Software WV-100/WV-100ST

INTERCONNECTION DIAGRAM

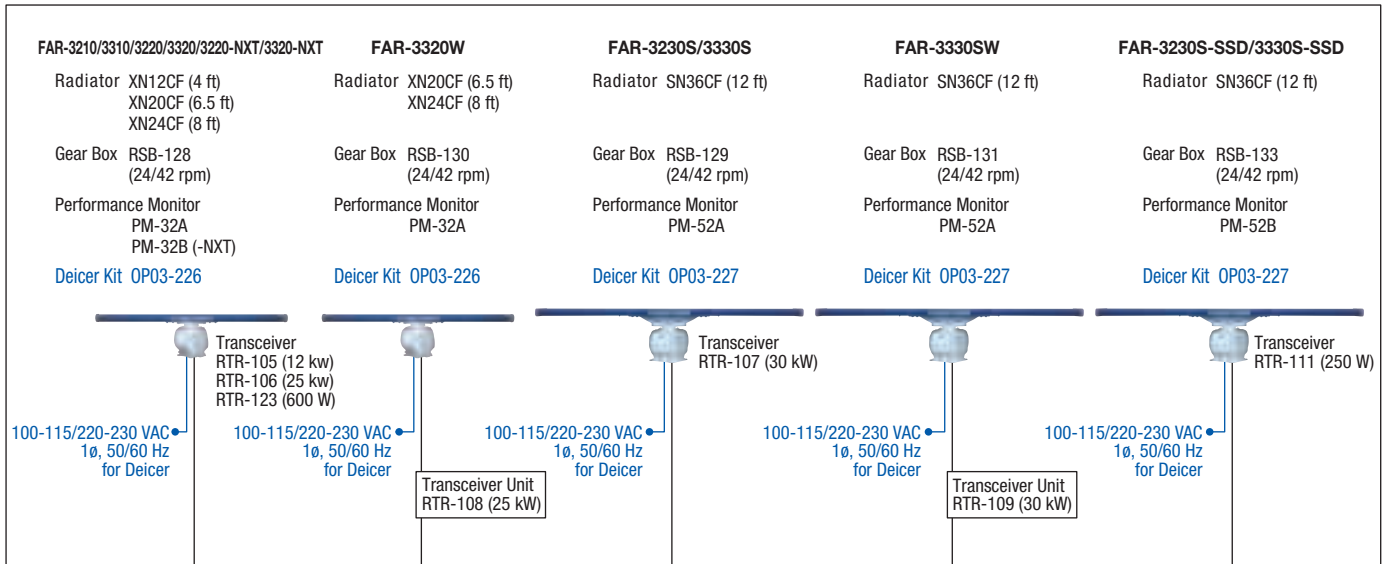

- Note:
1. Length of LAN cable is 50 m (max.)
 2. Cable between Sensor Adapter components should be no longer than 6 m.

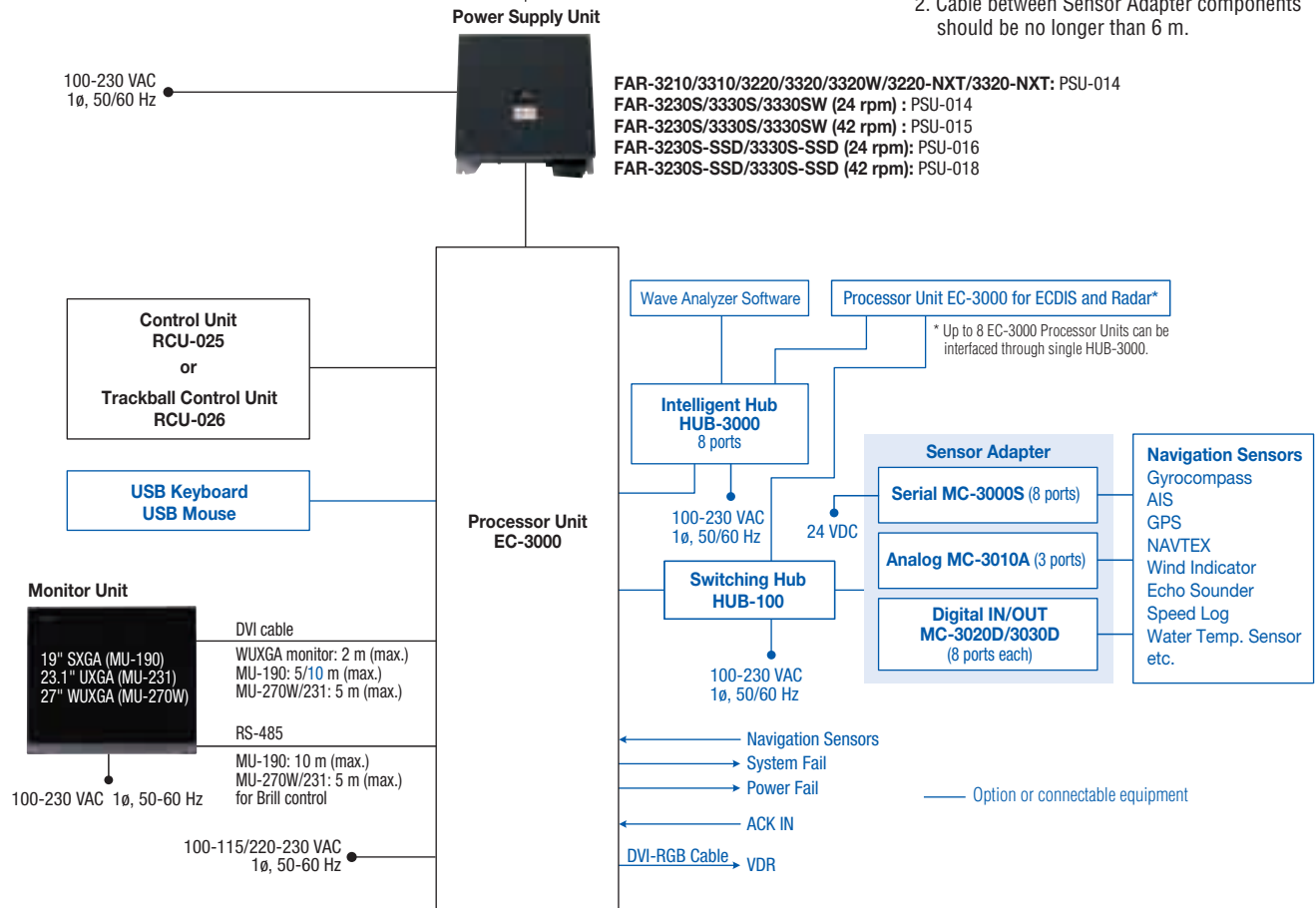

Model	Output Power	Transceiver Unit	Gear Box	Radiator Length	Rotation	Power Supply Unit		Display Unit			
						24 rpm	42 rpm				
FAR-3210	X band 12 kW	RTR-105	RSB-128	4 ft (XN12CF)	24/42* rpm	PSU-014		19.0" SXGA (MU-190)			
FAR-3310		RTR-106		6.5 ft (XN20CF)				27" WUXGA (MU-270W) or 23.1" UXGA (MU-231)			
FAR-3220		RTR-108	RSB-130	8 ft (XN24CF)				19.0" SXGA (MU-190)			
FAR-3320				27" WUXGA (MU-270W) or 23.1" UXGA (MU-231)							
FAR-3320W		27" WUXGA (MU-270W) or 23.1" UXGA (MU-231)									
FAR-3220-NXT	X band 600 W	RTR-123	RSB-128	4 ft (XN12CF)	24/42* rpm	PSU-014		19.0" SXGA (MU-190)			
FAR-3320-NXT		RTR-107		6.5 ft (XN20CF)				27" WUXGA (MU-270W) or 23.1" UXGA (MU-231)			
FAR-3230S	S band 30 kW	RTR-109	RSB-131	12 ft (SN36CF)				PSU-014	PSU-015		19.0" SXGA (MU-190)
FAR-3330S											RTR-107
FAR-3330SW		RTR-109	8 ft (XN24CF)	27" WUXGA (MU-270W) or 23.1" UXGA (MU-231)							
FAR-3230S-SSD	S band 250 W	RTR-111	RSB-133	12 ft (SN36CF)	PSU-016	PSU-018		19.0" SXGA (MU-190)			
FAR-3330S-SSD								27" WUXGA (MU-270W) or 23.1" UXGA (MU-231)			

* Except for XN24CF

Antenna Unit for FAR-3210/3310/3220/3320/3320W/3220-NXT/3320-NXT

Radiator XN12CF 46.2 kg 101.9 lb
XN20CF 48.1 kg 106.1 lb
XN24CF 49.3 kg 108.7 lb

XN12CF: 1297 51.1"
 XN20CF: 2097 82.6"
 XN24CF: 2597 102.2"

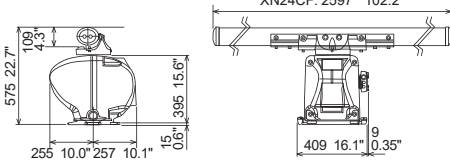

Antenna Unit for FAR-3230S/3330S/3330SW/3230S-SSD/3330S-SSD

Radiator SN36CF 144 kg 317.5 lb

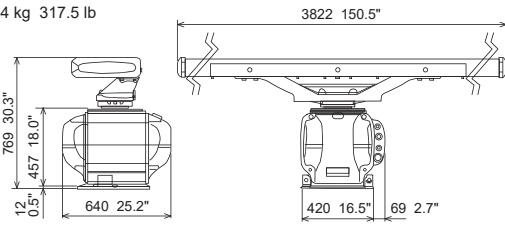

Monitor Unit

MU-190

8.8 kg 19.4 lb

MU-231

12.8 kg 28.2 lb

MU-270W

13 kg 28.7 lb

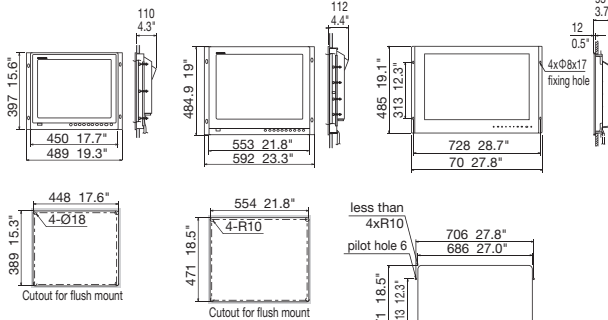

Transceiver Unit for FAR-3320W

RTR-108

17 kg 37.5 lb

Transceiver Unit for FAR-3330SW

RTR-109

22 kg 48.5 lb

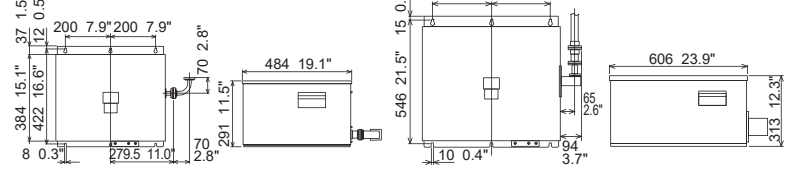

Power Supply Unit

PSU-014/016 8.5 kg 18.7 lb

PSU-015/018 10 kg 22.0 lb

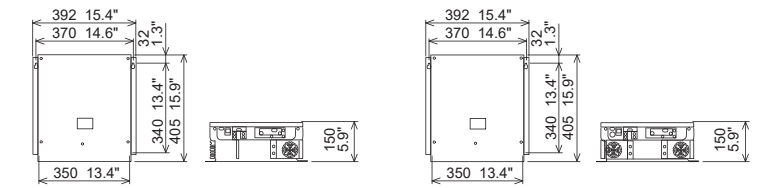

Control Unit

RCU-025 3.1 kg 6.84 lb

Trackball Control Unit

RCU-026 1.5 kg 3.31 lb

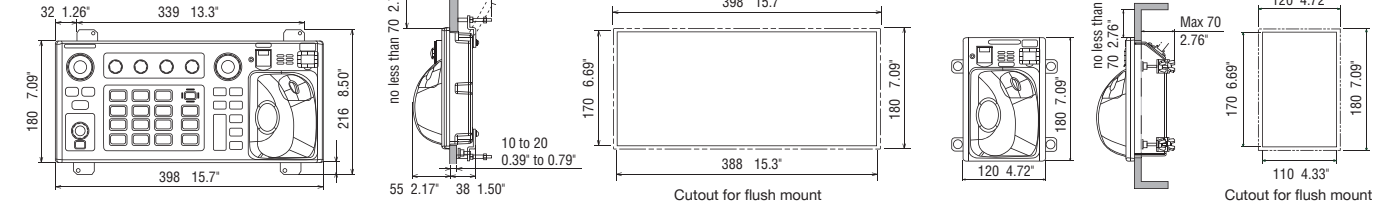

Processor Unit

EC-3000

14 kg 30.9 lb

Switching Hub

HUB-100 1.5 kg 3.31 lb

Intelligent Hub

HUB-3000

1.5 kg 3.31 lb

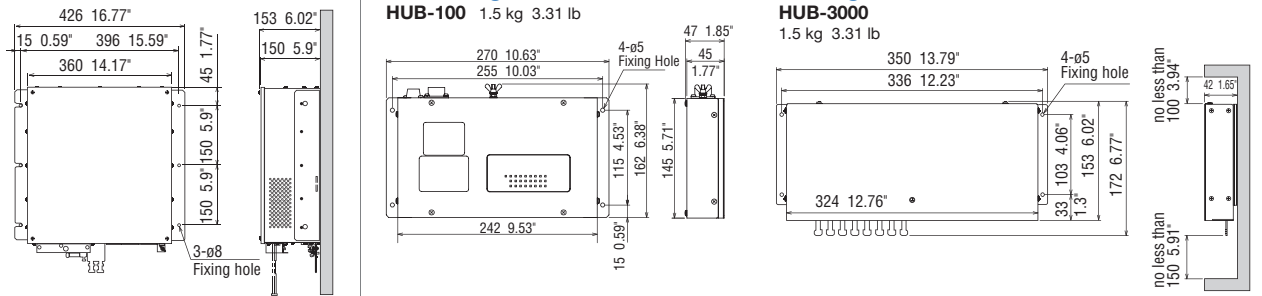

Sensor Adapter

Serial : MC-3000S 1.5 kg 3.3 lb

Analog : MC-3010A 0.8 kg 1.8 lb

Digital In : MC-3020D 0.8 kg 1.76 lb

Digital Out : MC-3030D 0.8 kg 1.76 lb

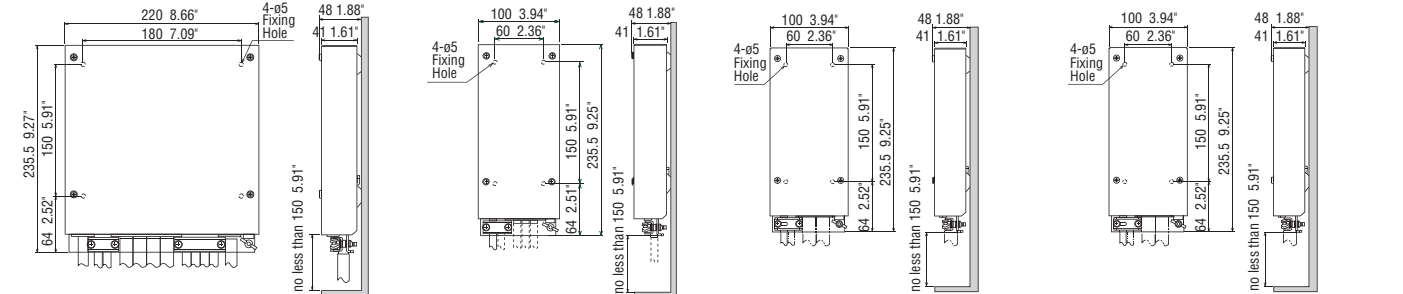

Beware of similar products

All brand and product names are registered trademarks, trademarks or service marks of their respective holders.

SPECIFICATIONS SUBJECT TO CHANGE WITHOUT NOTICE

FURUNO ELECTRIC CO., LTD.
Japan | www.furuno.com

FURUNO DANMARK A/S
Denmark | www.furuno.dk

FURUNO FRANCE S.A.S.
France | www.furuno.fr

FURUNO EURUS LLC
Russian Federation | www.furuno.ru

PT FURUNO ELECTRIC INDONESIA
Indonesia | www.furuno.id

FURUNO U.S.A., INC.
U.S.A. | www.furunousa.com

FURUNO SVERIGE AB
Sweden | www.furuno.se

FURUNO ESPAÑA S.A.
Spain | www.furuno.es

FURUNO SHANGHAI CO., LTD.
China | www.furuno.com/cn

FURUNO ELECTRIC (MALAYSIA) SND. BHD.

FURUNO PANAMA S.A.
Republic of Panama | www.furuno.com.pa

FURUNO FINLAND OY
Finland | www.furuno.fi

FURUNO ITALIA S.R.L.
Italy | www.furuno.it

FURUNO CHINA CO., LTD.
Hong Kong | www.furuno.com/cn

Malaysia | www.furuno.my

FURUNO (UK) LIMITED
U.K. | www.furuno.co.uk

FURUNO POLSKA Sp. Z o.o.
Poland | www.furuno.pl

FURUNO HELLAS S.A.
Greece | www.furuno.gr

FURUNO KOREA CO., LTD
Korea

FURUNO NORGE A/S
Norway | www.furuno.no

FURUNO DEUTSCHLAND GmbH
Germany | www.furuno.de

FURUNO (CYPRUS) LTD
Cyprus | www.furuno.com.cy

FURUNO SINGAPORE
Singapore | www.furuno.sg