

RADAR

Model: FAR-23x8 series

Keep Steady at Sea
with the safe, reliable and user-friendly next generation radar

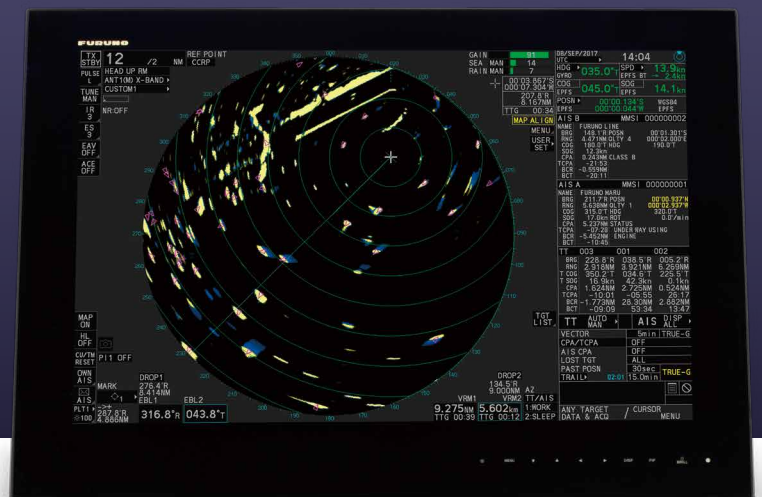

Keep Steady at Sea

with the safe, reliable and user-friendly next generation radar



RADAR

FAR-23x8 series

for Category 1 of ship/craft, with 27" wide or 23" LCD

- | | |
|---------------|-----------------------------------|
| FAR-2318 | X-band, 12 kW, TR up |
| FAR-2328 | X-band, 25 kW, TR up |
| FAR-2328W | X-band, 25 kW, TR down |
| FAR-2338S | S-band, 30 kW, TR up |
| FAR-2338SW | S-band, 30 kW, TR down |
| FAR-2338S-NXT | S-band, 250 W, TR up, Solid State |

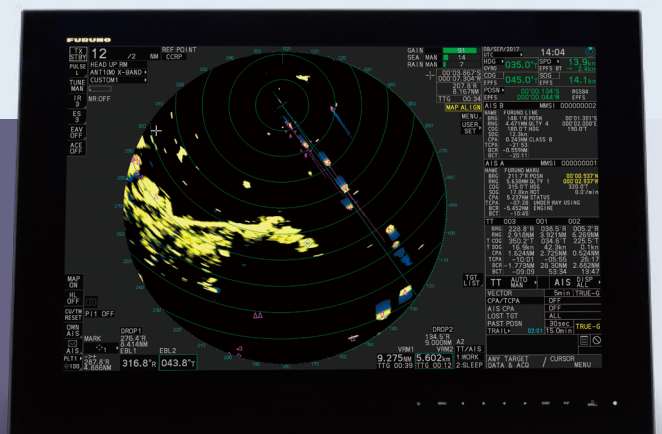

Complies with the following regulations:

IEC 62388 Ed.2.0	IEC 61162-1 Ed.5.0
IEC 62288 Ed.2.0	IEC 60945 Ed.4.0
IEC 61162-2	IEC 61162-450

Advanced technologies for safe navigation

The FURUNO FAR-23x8 series is a brand-new radar series characterized by its state-of-the-art antenna design and innovative signal processing techniques. FURUNO latest and finest technologies and intuitive design will increase situational awareness and enable safer than ever navigation.

► Automatic Clutter Elimination (ACE) for unprecedented echo clarity

Quickly adjusts the radar image with a single button press. When the ACE function is activated, the system automatically adjusts clutter reduction filters and gain control according to the sea and weather conditions.

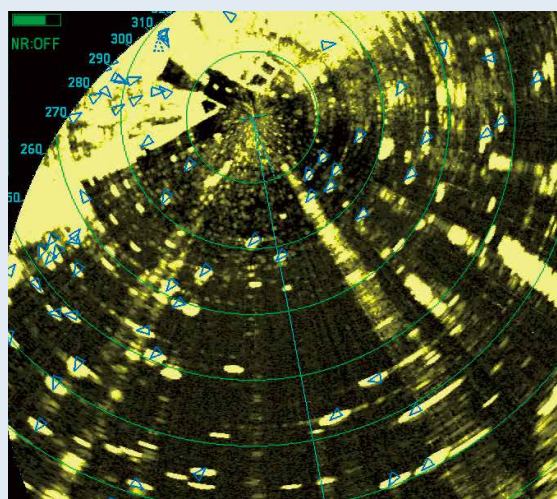

ACE OFF

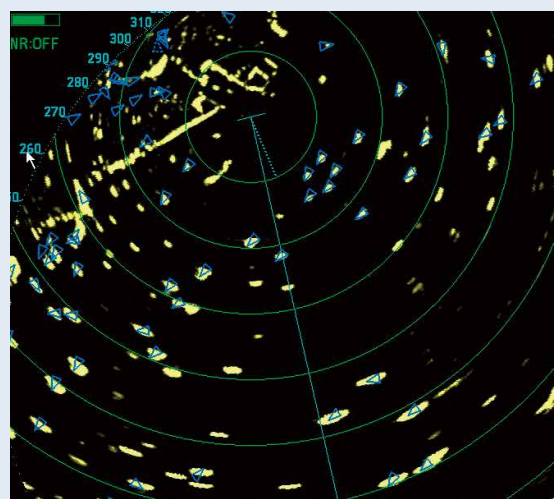

ACE ON

► Fast Target Tracking™ function to prevent collision at an early stage

With Fast Target Tracking™, the FAR-23x8 series provides accurate tracking information; speed and course vectors are displayed in mere seconds allowing operators to take action and avoid incidents at a very early stage.

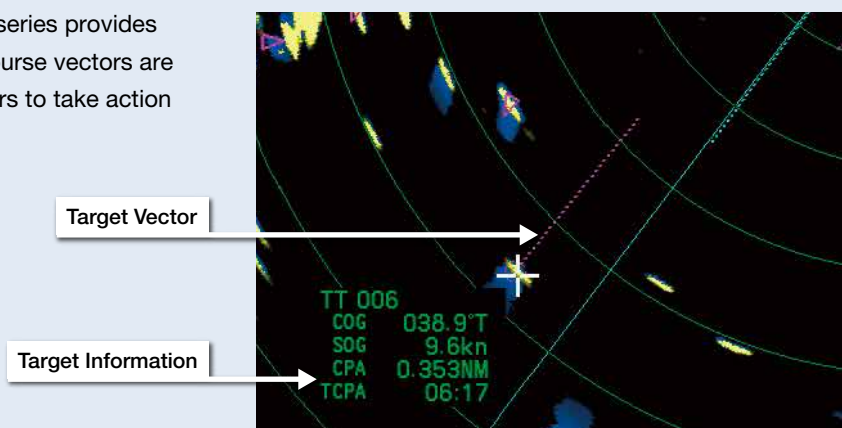

Read the QR cord to see detail explanations of above functions. ►►►





User interface designed for the ultimate intuitive operation

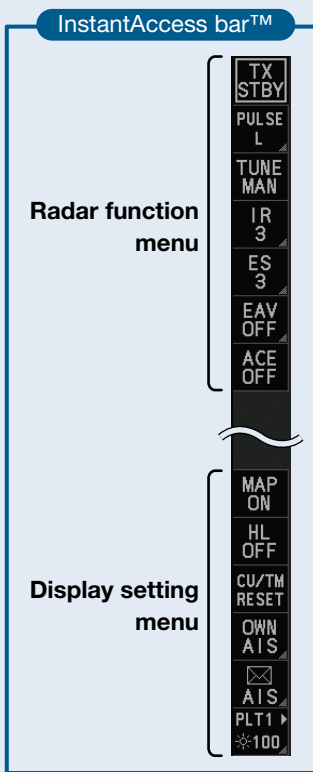

▶ **InstantAccess bar™** gives immediate access to the functions you need. InstantAccess bar™ contains shortcut menus of tasks (functions/actions) which operators frequently use, so users can quickly access necessary tasks.

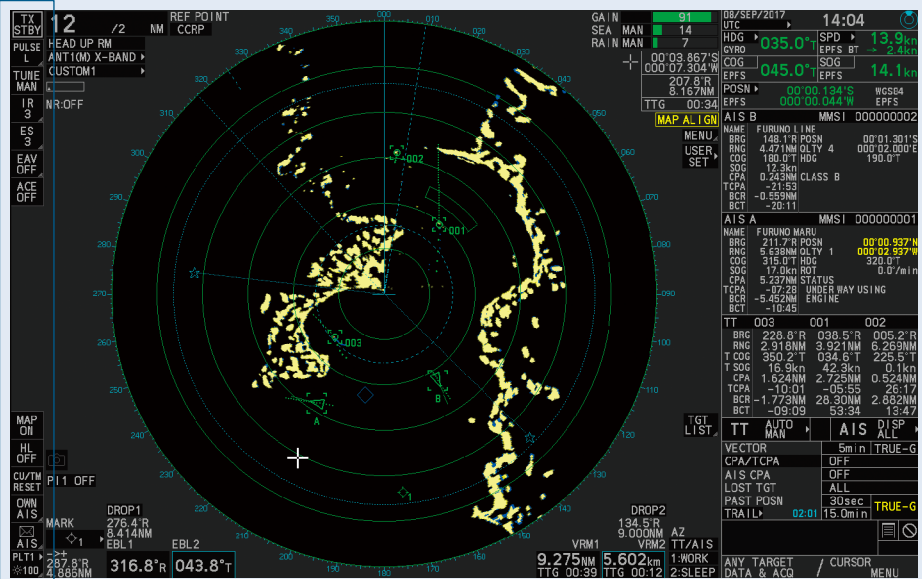

▶ Well-designed controllers for stress-free operation

Comfortable usability is very important on long voyages. With that in mind, these control units are designed based on ergonomics to fit the operator's hand. All operations can be controlled with the trackball.

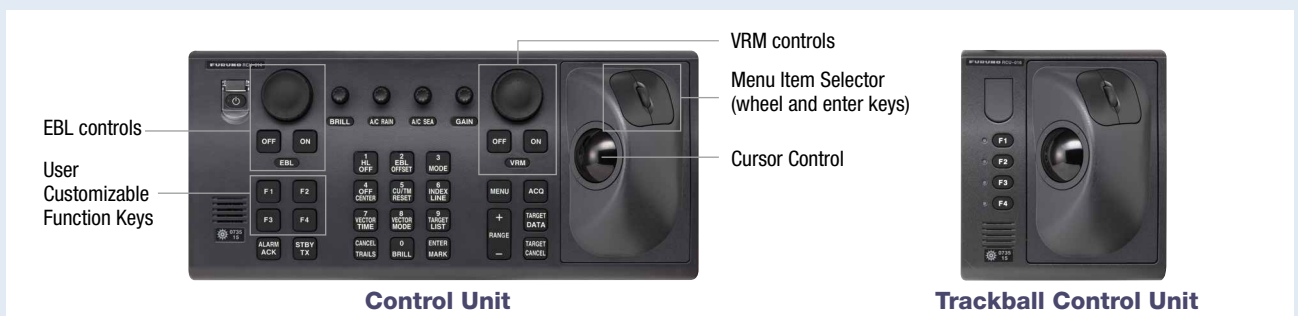



Refined antenna with high signal accuracy and excellent reliability



The FAR-23x8 series is designed to provide clearer and more accurate radar images of the surroundings while increasing reliability and decreasing overall cost of ownership with easy maintenance.

High image quality is achieved by the signal processor inside the antenna unit directly converting analog to digital signals before sending them to the main processor unit. Signals are safely transported through the Ethernet network between the antenna and below deck processing unit.

The new antenna shape suppresses aerodynamic drag and lightens the burden on the gear box.

The gear box itself has also been redesigned. Decreased aerodynamic drag and DC brushless motor result in a very durable gear box that can be used for prolonged period of time.

Installation and maintenance are now easier than ever. All components of the gear box are integrated into one block that can easily be removed from the gear box when maintenance is required. The cable to the gear box can be connected from the side of the gear box.

Solid State Radar model - NXT - specialized in target detection and maintainability (S-band only)

FURUNO Solid State Radars emphasize quality and reliability, while also meeting the rigorous demands of the marine environment.

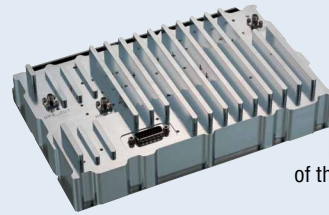

Power Amplifier Module of the Solid State transceiver

► Clear images

FURUNO Solid State Radar technology generates clear echo images, which allows users to obtain a clear picture of the area around their vessel, including weaker echoes from small craft.

► Reduced maintenance and running costs

Fan-less Solid State antenna dramatically reduces maintenance costs for the magnetron and CPU fan.

► Solid State Radar keeps almost same power ability as conventional magnetron radar.

Easy installation for new building as well as retrofits, with expanded capabilities

► 27" wide monitor (model: MU-270W) selectable.

With the expanded wide monitor, 9 TT data boxes will be displayed on the screen. The color contrast of the display is excellent so that radar echo can be grasped at a glance.

► Existing monitor, control unit and cables can be used in retrofitting*.

*Only when retrofitting in lieu of FAR-2xx7 series

► Optional LAN Signal Converter enables Ethernet communication. Also extension of the cable between antenna unit and processor unit utilizing existing cables when retrofitting is possible.

► Ethernet connectivity with onboard system

Ethernet expands the radar's capability with connection between either existing or newly installed system such as ECDIS and VDR.

► With the optional Ethernet HUB, Inter-switch can be utilized only with LAN cable.

► DVI-I cable is connectible to VDR in retrofitting.

How to connect VDR with FAR-23x8 series

VR-7000/7000S	Directly connect VDR with LAN or convert the RGB signal from a DVI-I port using video LAN converter, and input to the VDR.
VR-3000/3000S	Directly input the RGB signal from a DVI-I port to the VDR.
Other manufacturer's VDR	Please check with the VDR manufacturer to connect appropriately.

Product Name MARINE RADAR

Antenna Radiator

1. Type Slotted waveguide array

2. Beam width and sidelobe attenuation

Radiator type	X-Band			S-Band
	XN12CF	XN20CF	XN24CF	SN36CF
Length	4 ft	6.5 ft	8 ft	12 ft
Horizontal beam width	1.9°	1.23°	0.95°	1.8°
Vertical beam width	20°	20°	20°	25°
Sidelobe within ±10°	-24 dB	-28 dB	-28 dB	-24 dB
Sidelobe outside ±10°	-30 dB	-32 dB	-32 dB	-30 dB

3. Polarization Horizontal

4. Rotation 24 rpm or 42 rpm (for high speed craft)

5. Wind load 100 kn relative

6. De-icer (option) On: when temperature goes down to 0°C
Off: when temperature goes up to +5°C

Transceiver

1. TX Frequency and modulation

X-band (Magnetron)	9410 MHz ±30 MHz, P0N
S-band (Magnetron)	3050 MHz ±30 MHz, P0N
S-band (Solid state)	CH1 P0N: 3043.75 MHz/ Q0N: 3063.75 MHz ±5 MHz or CH2 P0N: 3053.75 MHz/ Q0N: 3073.75 MHz ±5 MHz

2. Output power

FAR-2318	12 kW
FAR-2328/2328W	25 kW
FAR-2338S/2338SW	30 kW
FAR-2338S-NXT	250 W (equivalent to magnetron radar 30 kW)

3. Range scale, Pulse Repetition Rate and Pulselength

Magnetron radar: FAR-2318/2328/2328W/2338S/2338SW

PRR (Hz approx.)	Range scale (NM)									
	0.125	0.25	0.5	0.75	1.5	3	6	12	24	48
3000	S1									
3000	S2									
1500	M1									
1200	M2									
1000	M3									
600*	L									

*: 500 Hz on 96 NM range.

Solid state radar: FAR-2338S-NXT

PRR (Hz approx.)	Range scale (NM)									
	0.125	0.25	0.5	0.75	1.5	3	6	12	24	48
2400	S1									
2000	S2									
1500	M1									
1060	M2									
1000	M3									
600	L									

Processor Unit

1. Minimum range 22 m

2. Range discrimination 26 m

3. Range accuracy

1% of the maximum range of the scale in use or 10 m, whichever is the greater

4. Bearing discrimination

2.1° (XN12CF), 1.5° (XN20CF), 1.2° (XN24CF), 2.0° (SN36CF)

5. Bearing accuracy ±1°

6. Range scale and Range ring interval (RI)

Range (NM)	0.125	0.25	0.5	0.75	1.5	3	6	12	24	48	96
RI (NM)	0.025	0.05	0.1	0.25	0.25	0.5	1	2	4	8	16
Number of rings	5	5	5	3	6	6	6	6	6	6	6

7. Warm-up time

3 min. approx. (solid state radar excluded)

8. Presentation mode

Head-up, STAB head-up, Course-up, North-up (RM/TM), Stern-up

9. Marks

Cursor, Range ring, Heading mark, North mark, Bearing mark, Target trail, VRM, EBL, Acquisition zone

10. Target tracking (TT)

Auto or manual acquisition 100 targets in 24/32 NM
(range selected from menu for maintenance)

Auto tracking on all acquired targets,

Tracking 5/10 pts on all targets

Vector time Off, 30 s, 1-60 min

11. AIS

Display capacity 350 targets

Tracking 5/10 pts on activated targets

Vector time Off, 30 s, 1-60 min

12. Radar map

20,000 points

13. Acquisition zone

2 zones

14. Interswitch function

Selectable from menu

Display Unit

1. Screen type

MU-231	23.1-inch color LCD, 1600 x 1200 (UXGA)
MU-270W	27-inch color LCD, 1920 x 1200 (WUXGA)

2. Brightness

MU-231/270W	400 cd/m ² typical
-------------	-------------------------------

3. Visible distance

MU-231	1.2 m nominal
MU-270W	1.02 m nominal

4. Radar effective diameter

MU-231	340 mm
MU-270W	350 mm

Interface

1. Number of port (processor unit)

Serial	7 ports (IEC61162-1/2: 2 ports, IEC61162-1: 4 ports, AD-10: 1 port)
Alarm output	6 ports: contact signal, load current 250 mA (Normal close/ open: 4, System fail: 1, Power fail: 1)
DVI output	2 ports: DVI-D, DVI-I or RGB picture data (VDR)
LAN	2 ports: Ethernet 100Base-TX
RS-232C	1 port: brilliance control
Sub display (for ECDIS)	2 ports: HD, BP, Trigger and Video signal

2. Data sentences (IEC61162-1/2, IEC61162-450)

Input	ABK, ACK, ACN, ALR, BWC, BWR, CUR, DBK* ¹ , DBS* ¹ , DBT, DDC, DPT, DTM, GGA, GLL, GNS, HBT, HDT* ¹ , MTW, MWW, OSD, RAQ, RMB, RMC, ROT, RTE, THS, VBW, VDM, VDO, VDR, VHW, VSD, VTG, VWR* ¹ , VWT* ¹ , WPL, ZDA
Output	ABM, ACK, AIQ, ALC, ALF, ALR, ARC, BBM, DDC, EVE, HBT, OSD, RSD, TLB, TLL, TTD, TTM, VSD

*1: for retrofit.

3. Ethernet interface for IEC61162-450

Port (LAN2)	100Base-TX, IPv4, 8P8C connector
IEC61162-450 transmission group	
Input	MISC, TGTD, SATD, NAVD, TIME, PROP
Output	Arbitrary (default: TGTD)
Multicast address	239.192.0.1 to 239.192.0.16
Destination port	60001 to 60016
Re-transmittable binary image transfer	
Multicast address	239.192.0.26 to 239.192.0.30
Destination port	60026 to 60030
Other network function excepted IEC61162-450	SNMP, HTTP, Syslog, Furuno Management Protocol (FMP)

4. Output port on antenna unit

Sub display (for radar) 1 port: HD, BP, Trigger and Video signal

Power Supply

1. Processor unit (w/antenna and transceiver unit)

FAR-2318	100-230 VAC: 2.2-1.1 (2.8-1.4) A, 1 phase, 50-60 Hz
FAR-2328/2328W	100-230 VAC: 2.6-1.3 (3.9-1.7) A, 1 phase, 50-60 Hz
FAR-2338S/2338SW	100-230 VAC: 3.9-1.7 (6.6-2.8) A, 1 phase, 50-60 Hz
FAR-2338S-NXT	100-230 VAC: 3.0-1.5 (5.8-2.6) A, 1 phase, 50-60 Hz (): 42 rpm

2. Display Unit

MU-231	100-230 VAC: 1.0-0.6 A, 1 phase, 50-60 Hz
MU-270W	100-230 VAC: 0.7-0.4 A, 1 phase, 50-60 Hz

3. HUB (option)

100-230 VAC: 0.1 A max. 1 phase, 50/60 Hz

4. De-icer (option)

100-115/220-230 VAC: 2.6/1.3 A, 1 phase, 50-60 Hz

Environmental Conditions

1. Ambient temperature

Antenna unit	-25°C to +55°C (storage: -25°C to +70°C)
Indoor units	-15°C to +55°C (storage: -20°C to +70°C)

2. Relative humidity

95% or less at +40°C

3. Degree of protection

Antenna unit	IP56
Processor/ monitor unit	IP22
Control unit	IP20
HUB	IP20 (HUB-100), IP22 (HUB-3000)

4. Vibration

IEC 60945 Ed.4

Equipment List

Standard

- Display Unit MU-231/MU-270W
- Processor Unit RPU-025
- Control Unit RCU-014
Trackball Control Unit (Specify when ordering) RCU-015
- Antenna Radiator XN12CF/XN20CF/XN24CF/SN36CF
- Transceiver RTR-105/106/107/108/109/111
- Gear Box RSB-128/129/130/131/133
- DVI cable (5 m) DVI-D/D S-LINK 5M
- Standard Spare Parts and Installation Materials
- Performance Monitor PM-32A/52A/52B

Option

- Remote Control Unit RCU-016
- Junction Box RJB-001
- AD Converter AD-100-E
- Switching HUB HUB-100
- Intelligent HUB HUB-3000
- De-icer OP03-226/227/231/232
- LAN Signal Converter
X-band OP03-247-3, S-band (magnetron) OP03-247-2, S-band (NXT) OP03-247-1

INTERCONNECTION DIAGRAM

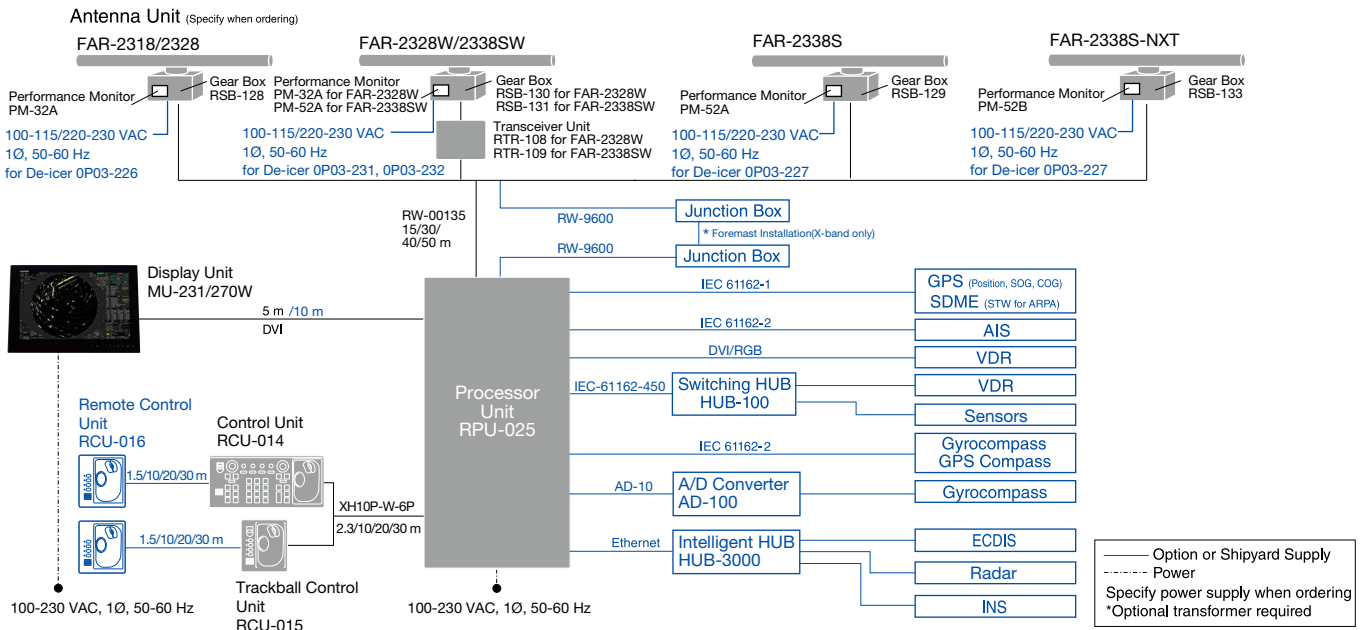

Transceiver Unit for FAR-2328W

RTR-108 17.0 kg 37.5 lb

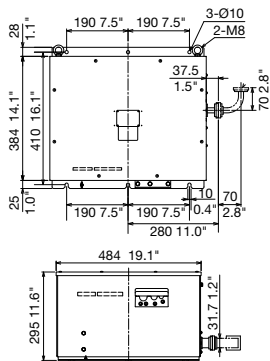

Processor Unit RPU-025

X-band/ S-band 24rpm w/ Fan 9.6 kg 21 lb
S-band 42rpm w/ 2 Fan 11.5 kg 25 lb

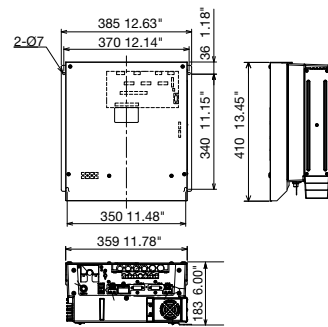

Transceiver Unit for FAR-2338W

RTR-109 24.0 kg 55.1 lb

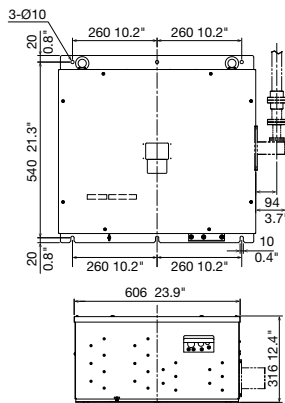

Control Unit RCU-014

2.5 kg 5.5 lb

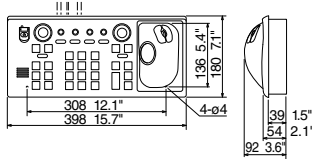

Trackball Control Unit RCU-015

2.4 kg 5.3 lb

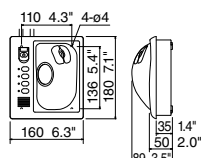

Remote Control Unit RCU-016

2.4 kg 5.3 lb

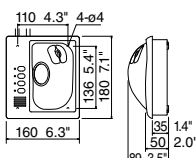

Display Unit

MU-231

12.8 kg 28.2 lb

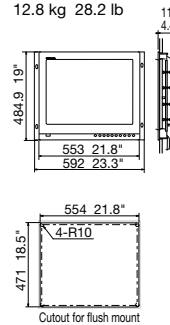

MU-270W

13 kg 28.7 lb

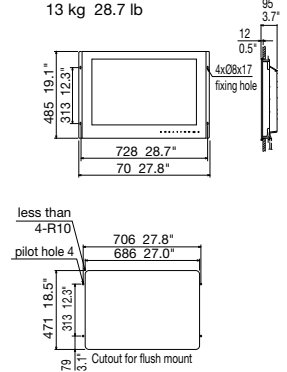

Antenna Unit for FAR-2318/2328/2328W

Radiator XN12CF 46.2 kg 101.9 lb
XN20CF 48.1 kg 106.1 lb
XN24CF 49.3 kg 108.7 lb

XN12CF: 1297 51.1"
XN20CF: 2097 82.6"
XN24CF: 2597 102.2"

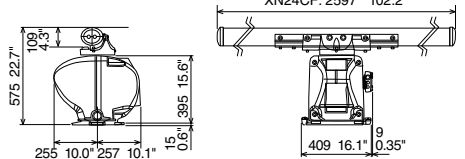

Antenna Unit for FAR-2338S/2338SW/2338S-NXT

Radiator SN36CF 144 kg 317.5 lb

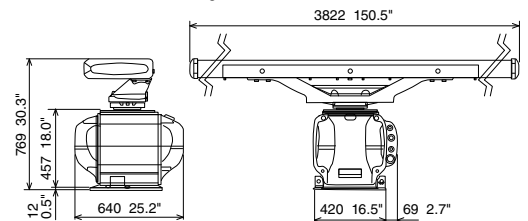

Beware of similar products

All brand and product names are registered trademarks, trademarks or service marks of their respective holders.

SPECIFICATIONS SUBJECT TO CHANGE WITHOUT NOTICE

FURUNO ELECTRIC CO., LTD.
Japan | www.furuno.com

FURUNO U.S.A., INC.
U.S.A. | www.furunousa.com

FURUNO PANAMA S.A.
Republic of Panama | www.furuno.com.pa

FURUNO (UK) LIMITED
U.K. | www.furuno.co.uk

FURUNO NORGE A/S
Norway | www.furuno.no

FURUNO DANMARK A/S
Denmark | www.furuno.dk

FURUNO SVERIGE AB
Sweden | www.furuno.se

FURUNO FINLAND OY
Finland | www.furuno.fi

FURUNO POLSKA Sp. Z o.o.
Poland | www.furuno.pl

FURUNO DEUTSCHLAND GmbH
Germany | www.furuno.de

FURUNO FRANCE S.A.S.
France | www.furuno.fr

FURUNO ESPAÑA S.A.
Spain | www.furuno.es

FURUNO ITALIA S.R.L.
Italy | www.furuno.it

FURUNO HELLAS S.A.
Greece | www.furuno.gr

FURUNO (CYPRUS) LTD
Cyprus | www.furuno.com.cy

FURUNO EURUS LLC
Russian Federation | www.furuno.ru

FURUNO SHANGHAI CO., LTD.
China | www.furuno.com/cn

FURUNO CHINA CO., LTD.
Hong Kong | www.furuno.com/cn

FURUNO KOREA CO., LTD
Korea

FURUNO SINGAPORE
Singapore | www.furuno.sg

PT FURUNO ELECTRIC INDONESIA
Indonesia | www.furuno.id